

Bedienungs- und Wartungsanleitung
Operation and Maintenance Manual

PERROT

Steuergerät Water Control+ SC
Controller Water Control+ SC



Table of Contents

1. General

2. Safety

3. Description

4. Installation

5. Commissioning

6. Maintenance

7. Troubleshooting

1. General

We assume that you are familiar with the general issues of irrigation. This manual is therefore brief and contains only information, which needs to be at hand during system operation.

Warranty claims may only be made if the controller has been operated according to instructions set forth in this manual and if the fault occurs during the warranty period.

1.1. Application

The Water Control can be used for programmed opening and closing of 24V/50Hz valves. The valves are predominantly used in the irrigation systems.

Operating temperature: 0°C to 50°C

Storing temperature: -20°C to 50°

1.2 Warranty Information

Regnerbau Calw GmbH warrants to its trade customers that its products will be free from original defects in material and/or workmanship. The provided product is used for irrigation, in accordance with recommendations as specified by the manufacturer, for the duration of the warranty period specified hereinafter. The warranty does not cover controller faults caused by act of God (storms, floods, etc.).

During the warranty period, Regnerbau Calw GmbH will repair or replace all faulty parts, at its own discretion, but limits its liability to defective components only. Any other explicit and/or implied warranties are excluded.

In the unlikely case of a claim, please return the faulty component to your local supplier or contact our customer service department at:

Regnerbau Calw GmbH, Industriestrasse 19-29, 75382 Althengstett, Germany.

This warranty does not cover controllers used and/or installed and/or modified in contravention of the technical data or operating/installation instructions as issued by Regnerbau Calw GmbH.

Regnerbau Calw GmbH waives any liability for indirect or subsequent damage incurred in connection with using the controller, including but not limited to damage to plant material, cost of technology/service replacement; incurred during the existence of the fault or due to the controller being out of operation; damage to other property; injuries to the operator(s) caused by negligence or by other reasons.

All automatic guarantees, including guarantees for typical quality or suitability of the merchandise are limited to the warranty period as specified by law.

2. Safety

This operation & safety manual contains basic instructions for installation, operation, maintenance and repair of the controller. It is absolutely necessary that the professional installation technician and qualified staff/operator study this manual thoroughly prior to initiating the controller installation and commissioning.

Please follow both the general safety instructions specified in this chapter, and the particular safety warnings pointed out in other chapters.

2.1. Marking of Instructions in the Operating Manual

Safety instructions, non-compliance with which could lead to risking people's health are marked with the "danger" symbol:



"Warning" is printed next to instructions where non-compliance may represent a risk to the controller and/or its operation.

WARNING



When the controller is plugged into the mains, its transformer is powered up. Touching it may result in a life-threatening electric shock!

2.2. Risk in Case of Ignoring the Safety Instructions

Not respecting the safety instructions may result in serious injuries, damage to the environment and/or the controller. Not respecting the safety instructions may waive liability for all and any claims for covering damage.

3. Description

3.1 Performance

- ☆ *3 independent irrigation programs (A, B, C), with 4 start times each.
Expandable to 5 irrigation programs.*
- ☆ *Station run time 1 – 99 min.*
- ☆ *Irrigation calendar for 7 days*
- ☆ *Manual start of individual stations or programs*
- ☆ *Start via key switch*
- ☆ *Seasonal adjustment from 20 – 200 % by water budget function*

3.2 Electric Data

- ☆ *Power supply: 230VAC, 50Hz*
- ☆ *Output voltage 24VAC*
- ☆ *Permanent output current 300mA*
- ☆ *Short-term output current 450mA*
- ☆ *Short-circuit protected outputs*
- ☆ *In case of a power cut, the time and programmed data will be saved by a backup battery.*

3.4 Inputs and outputs

- ☆ *Station connections – variable from 4 to 24 stations*
- ☆ *2 to 12 station connections when using the Sector Scout function*
- ☆ *24VAC master-valve or a pump relay*
- ☆ *Potential free opener contact (rain sensor)*
- ☆ *Permanent 24VAC*

3.4 Indicators and functions

- ☆ *LC display 70x40mm*
- ☆ *Displays time and status bar*
- ☆ *5 multi-function keys*

3.5 Dimensions and miscellaneous

- ☆ *Plastic housing dimensions:
length: 350mm; width: 270mm; height: 110mm*
- ☆ *8 field cable connection lugs with safety snag feature*
- ☆ *Programmable station delay times (0-99 sec.) ensure proper pressure conditions
when valves open and close*
- ☆ *Pump after-run time (0-15 sec.) for pressure stabilization*

4. Installation

4.1 Wall mounting

- ☆ Choose a dry location protected from direct sunlight for the installation of the controller
- ☆ Remove the front cover (see chapter 5) and fix the back cover of the housing to the wall with three screws (included in the package).

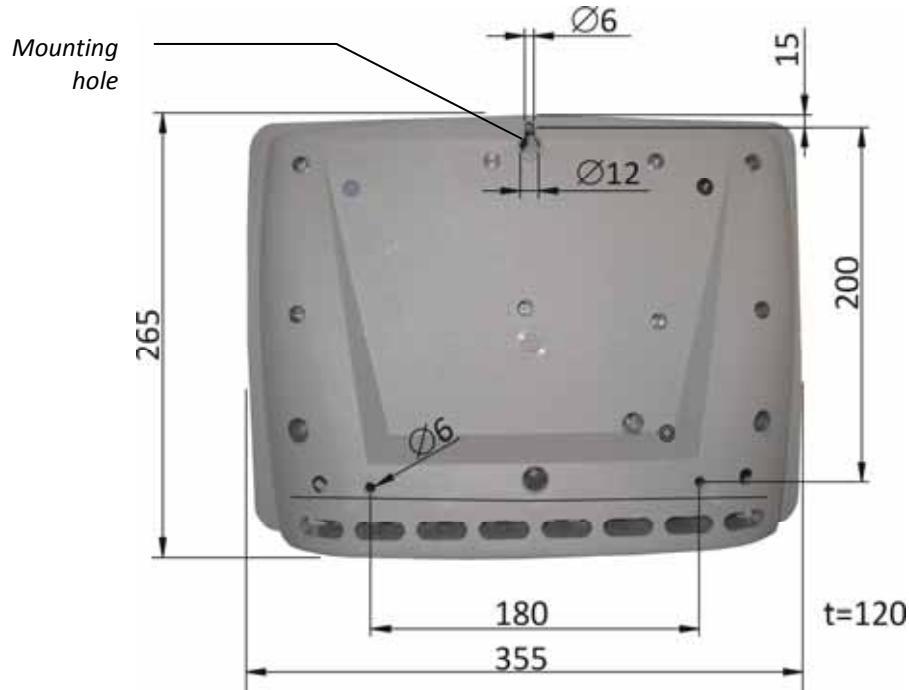

WARNING

Please note that the controller may touch the wall only at the points with screw holes.

Do not plug the controller into the mains until it is mounted on the wall, all valves are connected and the front cover is fixed back in place.

4.2 Connect Controller and Valves

Wiring diagram

for rain sensor



for external start with key switch

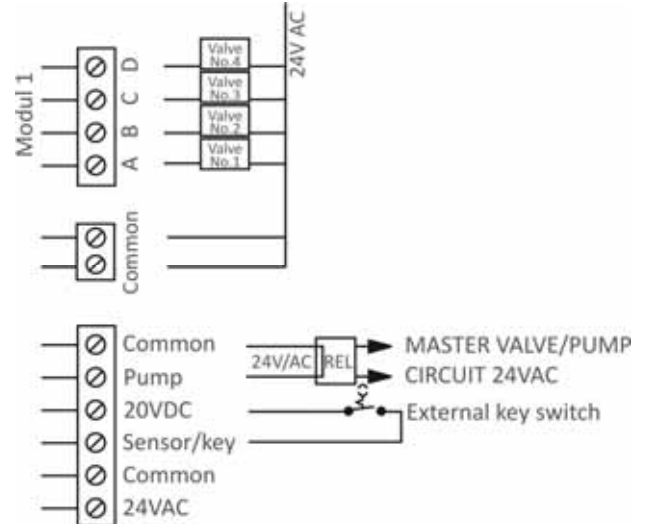

for short time clock

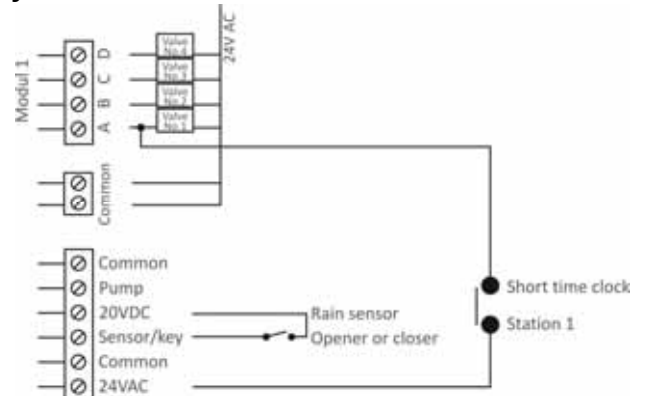

for VP3 + Sector Scout

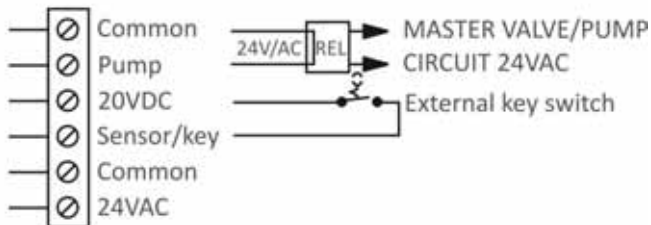
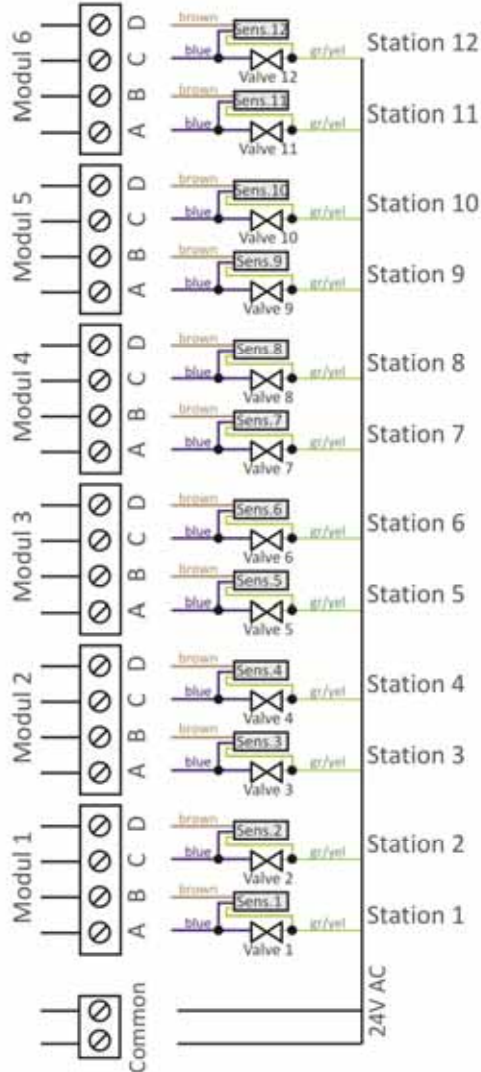
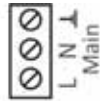

WARNING



If both, stations with Sector Scout (VP3SC) and stations with valves only are connected to the same controller, the stations with Sector Scout need to be connected one by one starting with module 1. The valves can then be connected to the remaining modules regardless of their order.

Connect controller and valves

- ☆ *Connect all valves and inputs/outputs according to the wiring diagram.*

WARNING

- ☆ *Use field cable connection lugs with safety snag feature included in the package for all cables.*
- ☆ *The output current must not exceed 150mA/coil*

Master valves and pump relays

WARNING

- ☆ *There must be at least a 5m distance between the pump relay and the controller, thus avoiding and protecting the device from voltage peaks.*

Connect rain sensor

- ☆ *Both, normally open contacts or normally closed contacts can be used as a rain sensor.*
- ☆ *Connect rain sensor as per wiring diagram.*
- ☆ *Turn the main dial to "Setup" and set appropriate type of rain sensor (opener or closer).*

Connect key switch for external program start (Order-no.: SB49165)

- ☆ *Connect key switch as per wiring diagram.*
We recommend to use:
 - *Jung key switch 833.18W; WG 800 IP44 contact (opener/closer) and*
 - *Jung profile cylinder for key switch UP3 key (closer), 3051938 Jung 28 (Granzow order no.)*
 - *Turn the main dial to "Setup" and select key switch (page 16).*

Connect short time clock (external switch)

- ☆ *Valves with short time operation may be activated directly on site, using the permanent 24VAC contact (see wiring diagram). This circuit is commonly used on tennis courts in order to eliminate dust by short-term irrigation.*



Note: *The master valve will not start when activating the valves by means of a short time clock. This will require special cabling. Please contact the manufacturer.*

5. Initial Startup

Controller

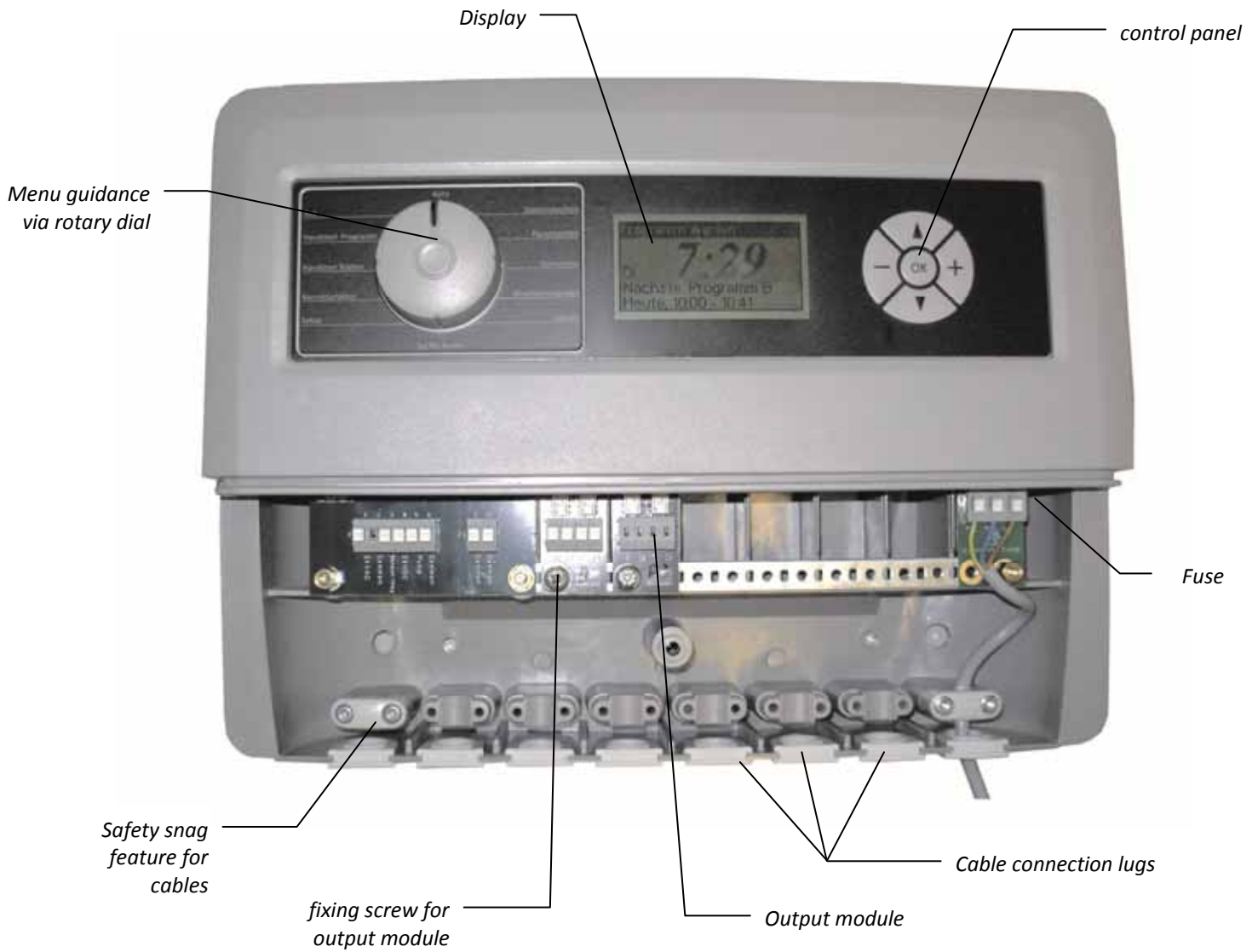

Display

When the controller is powered on for the first time, the following startup screen is displayed:

Current menu and status bar

Current time

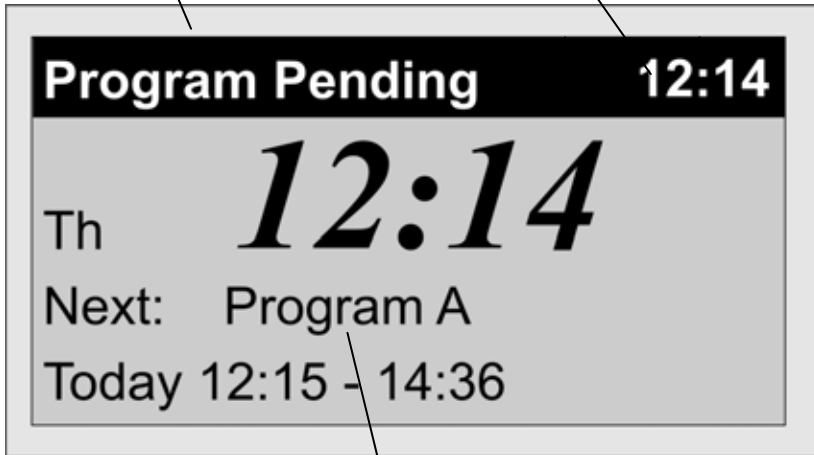

Work area

Programming

Menu Selection

You can select menu 1 to 12 using the rotary dial.

The currently selected menu is indicated in the display header line.

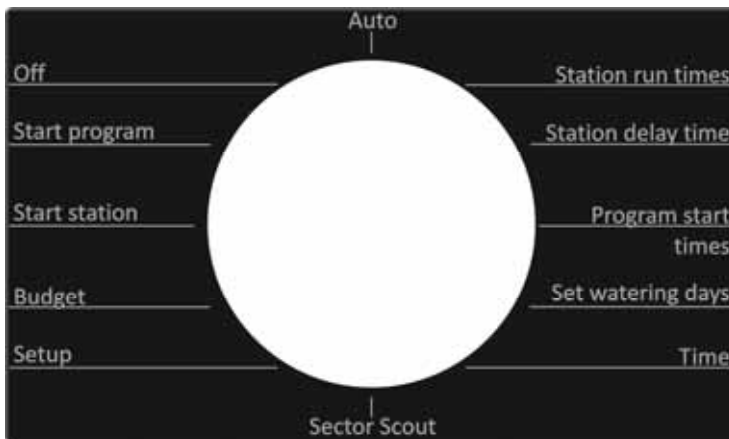

Keys and their Functions

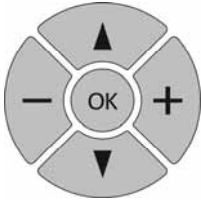

The controller has 5 keys with the following functions:



: press "OK" to confirm. All changes will automatically be discarded when leaving the menu without pressing "OK"



: increases the selected value



: decreases the selected value







: scrolls up through menu



: scrolls down through menu







Set current date / time

5. To access the menu, turn the main dial to Time
6. To make a selection use  or  Taste. The selected menu function will start flashing.
7. Use  or  to set current time and day.
8. Press OK to save the changes made before leaving the menu.

Note: ⇒ **Date and time settings will be saved for at least one year in case of power outages.**







Set Station Run Times

9. To access the menu, turn the main dial to Station Run Times.
10. Press the  or  buttons to select program (A, B or C). The program selected will be flashing.
11. Press  to confirm. The current station is indicated by a flashing box/block or line at the far right of the display.
12. Set the required run time for this station using  or .
13. Press the  and  buttons to move to the next station.
14. Repeat steps 4 and 5 for all stations.
15. Press OK to confirm and save station run time.
16. Repeat steps 2 to 6 for all programs.
17. Station run times can be set from 0 – 99 minutes.

Note: ⇒ If the controller has 2 output modules, you can program only 8 stations (2 modules × 4 stations).



Set Station delay time

5. To access the menu, turn the main dial to Station Delay Time.
 6. The selected menu function will start flashing. Press the  and  buttons to navigate from station run times to station delay time.
 7. Set the required station delay time using  and .
 8. Save values entered by leaving the menu but press OK before leaving the menu.
- ☆ The station delay time can be set from 0-99 seconds.

Note: ⇒ **Station delay time:** This feature delays the start of the next sequential station in a program after the previous station completes.
 ⇒ **Pump after-run time:** To avoid pump low pressure trips the pump may continue running for a certain amount of time after the last sprinkler closes.



Set Program Start Times

6. To access the menu, turn the main dial to Program Start Times.
7. Press the and buttons to select the program (A, B or C) to be altered and press to confirm.
8. Program start times can be set in increments of 5 minutes using and .
9. Use the and buttons to set a second (third and fourth) start time, if needed.
10. Repeat steps 2 – 4 if you want to set start times for other programs (A, B or C) and confirm with .



Note: Only if the start time is set to --:-- --:-- the program will not start at all.

Set Watering Days

8. To access the menu, turn the main dial to Set Watering Days.
9. Press the and buttons to select the program (A, B or C) and press to confirm.
10. Select start time 1, 2, 3 or 4 using and .
11. Press and to set watering days. Irrigation will then be activated on a weekly basis.
12. To deactivate a particular day use . The display will automatically advance to the next day.

Line	—	= no irrigation
Day (e.g. SA)		= irrigation activated

13. To activate a particular day use . The display will automatically advance to the next day.
Repeat steps 4 and 5 until all watering days for the whole week have been set and press to confirm.

14. Repeat steps 3 to 6 for other start times of the program.







Repeat steps 2 to 6 for other irrigation programs.

Note:







- ⇒ To make sure that the irrigation programs do not overlap, turn the dial to AUTO
- ⇒ If the display shows ERROR it will also show which programs do overlap. Please edit start times and watering days accordingly and try again.

Manual Start of a Station

6. To access the menu, turn the main dial to Start Station.
7. Use the  and  buttons to select station and run time.
8. Press  and  to increase or decrease run time of the selected station. The run time can be set from 0 to 99 min.
9. Press  to start the station.
10. One more press will turn it off .

Manual Start of an Irrigation Program

6. To access the menu, turn the main dial to Start Program.
7. Press the  and  buttons to make a selection. The program selected will be flashing.
8. Press  to start the irrigation program.
9. The screen will display the time left of a program and of a station in minutes indicated by blocks.
10. One more press  will turn it off.

Note:





- ⇒ You can start a station or an irrigation program regardless of the rain sensor status.
- ⇒ If the dial is turned to AUTO during operation, it will continue in AUTO mode after the program has finished.

System Off

3. Turn the main dial to OFF.
4. The top left corner displays OFF and the screen shows current time and day of the week.

Note:



- ⇒ If irrigation was active, all valves close and all running programs stop. The stopped programs will not be re-activated even if the dial was set to AUTO.
- ⇒ All programmed data will remain unchanged
- ⇒ The ,  and  buttons have no function in this menu.
- ⇒ In this menu position all irrigation programs are off and can not be activated by a key switch.

Auto mode - Start -

4. Turn the main dial to AUTO.





- 5.
6. The screen will display any scheduled irrigation programs including start time and date only if a start time and watering day has been set (see Set Program Start Times).

Note:

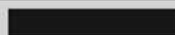

- ⇒ This menu runs all irrigation programs which have one or more pre-set start times and watering days.
- ⇒ If the rain sensor is enabled, “rain stop” and the time when the rain sensor was activated will be displayed on the screen. This mode will suspend all active irrigation programs and scheduled programs will be prevented from starting.
- ⇒ If an irrigation program is running, the screen shows:

Program active		12:25
Prg A		
	12:15	14:36
St 4		
	13:27	13:56

“program active”. Here you can see the progress statistic, start and stop times of the entire program as well as of individual active stations

- ⇒ The ,  and  buttons have no function in this menu.

Seasonal adjust / Water Budget



3. To access the menu, turn the main dial to Budget.

4.  and  will increase / decrease the percentage of adjustment. Min. 20%; Max. 200%.

Setup

The following functions may be selected and set here:

3. Turn the main dial to Setup.

4. Press  or  to make a selection. The program selected will be flashing. Press  to confirm.



Setup	
Rain sensor	Key
Language	UK
Programs	4
Info..	

A1: Rain sensor

☆ Factory setting = no rain sensor connected.



☆ Please make sure to connect rain sensor as per wiring diagram 4.2.



☆ Please check whether your rain sensor is a normally closed (N.C.) or normally opened (N.O.) contact.

☆ Press  and  to make a selection and confirm with .

A2: Key Switch

☆ Please make sure to connect key switch as per wiring diagram 4.2.

☆ Select "Rain sensor" by using the  and  buttons.

☆ Use  and  to navigate to "Key" and press  to confirm.



Note:



- ⇒ Turning the key switch will immediately start Prg.A
BUT only if the main dial is not turned to "SYSTEM OFF"
- ⇒ External program starts can be stopped by turning the key switch one more time.

B: Select Language

☆ Press the  and  buttons to select Language.

☆ Press  and  to make a selection and press  to confirm before leaving the menu:

DE= German

UK= English

CZ = Czech

PL = Polish

RU = Russian

NL = Dutch



DK = Danish

FR = French

C: Programs

☆ Factory setting = 3 irrigation programs (A/B/C) which can be expanded to 4 or 5 (A/B/C/D/E).

☆ Press  and  to select "Programs".

☆ Press  and  to increase/decrease the number of programs (1 to 5) and press  before leaving the menu.

D: Information

☆ This function is only for information purposes about the software and hardware used and is therefore only of minor importance to the customer.

Sector Scout

This feature can only be used in conjunction with the Perrot VP3 pop-up sprinkler with "SectorScout". For detailed operational information on this feature please see manual TDP070.

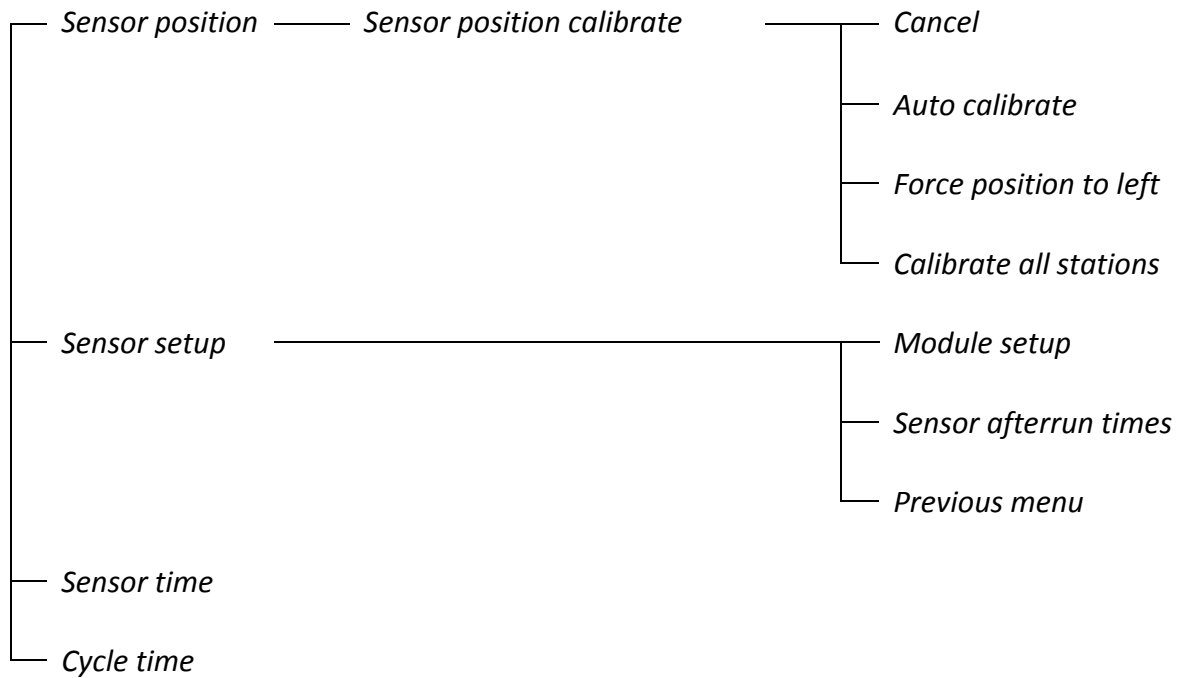

Menu structure



Before commissioning a system with VP3 Sector Scout sprinklers we recommend to proceed as described below.

Sensor Setup

The following functions can be edited in this menu.

☆ Press  and  to select the function you want, when it starts flashing press  to confirm.

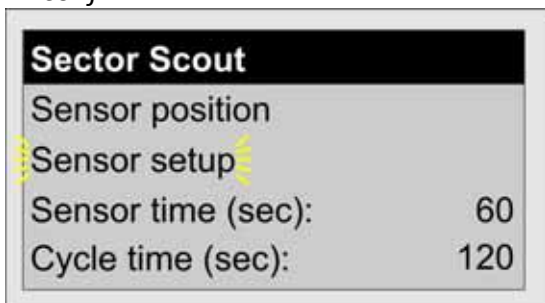

☆ Factory setting = only solenoids are connected, i.e. 4 solenoids (stations) per module can be connected.

- ☆ **Connect VP3 with Sector Scout as per wiring scheme on page 7.**
Please note that in this case only 2 stations per module can be connected.

Change entries in the controller software as follows:



Channel A: wired with solenoid and

Channel B: wired with position sensor

- ☆ Please proceed as follows:

- Press  and  to select „Module setup“ and press  to confirm.



- Press  and  to select a station where a VP3 with Sector Scout is supposed to be connected.

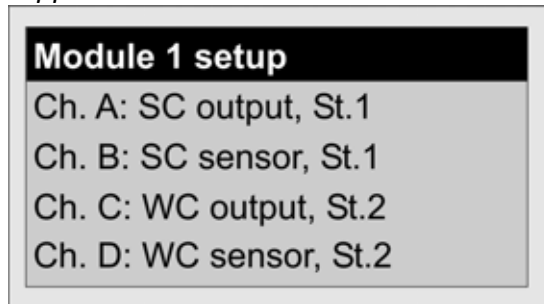

- Use  to set the selected station to „SC output“.

Warning





If both, stations with Sector Scout (VP3SC) and stations with valves only, are connected to the same controller, all stations with Sector Scout have to be connected in consecutive order starting from module 1. The valves (no Sector Scout) can then be connected to the remaining modules regardless of their order.

- press  to confirm entry.
- To get back to the „Sector Scout“ menu, press „previous menu“.

Sensor position

This menu will show you how to bring all sprinklers into one defined home position (calibrate), the so-called „parking position“, meaning arc setting to the left.

☆ Use the  and  keys to select „sensor position“ and press  to confirm.

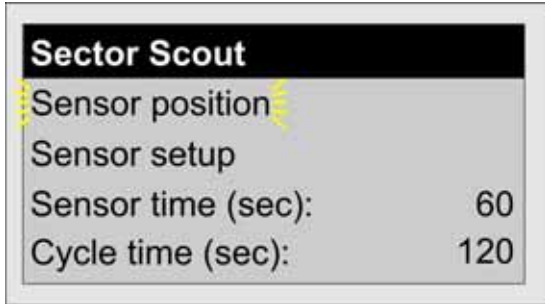

The display will now show all stations with Sector Scout.

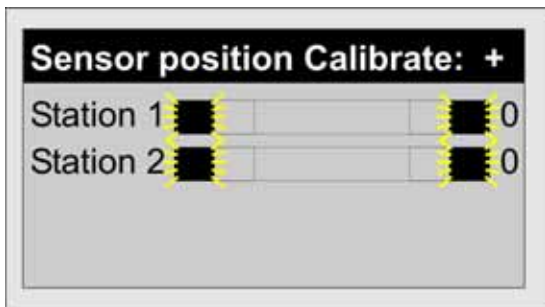

The black blocks along the bar show the progress of each station with Sector Scout. Please see page 25 “sensor position bar” for detailed explanation of each signal.

☆ Use the  and  keys to select a station

☆ Press  to enter the selection menu which will offer you the following options:

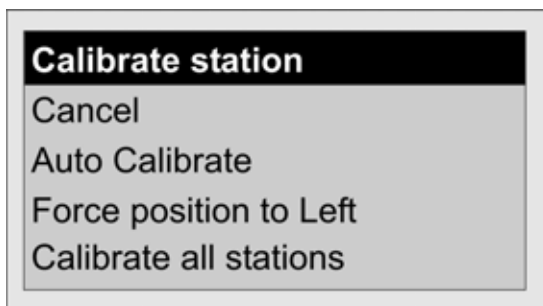

Cancel

☆ „Cancel“ will bring you back to the previous menu.

Auto calibrate

☆ If you choose “Auto calibrate” and press  the selected station will automatically be calibrated. Please make sure that pressure is made available to the sprinkler before starting the calibration process.

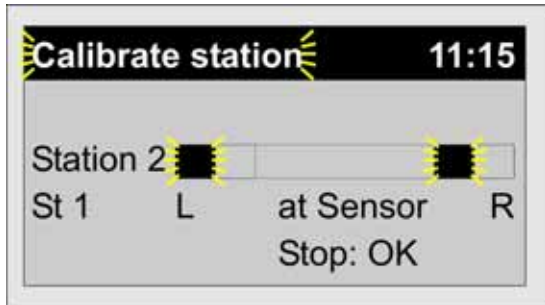

Warning
Sprinkler starts !

Press  to leave the menu after calibration has finished.

Force position to left

If you choose this function the sprinkler needs to be brought into parking position manually.



Note: It is feasible to bring all sprinklers, one after another, manually into parking position (arc setting to the left, sensor may not touch the switching cams).

Then press  for each station to confirm the calibration process.

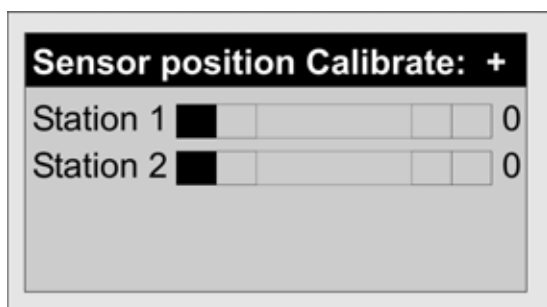

The black square on the left of the bar indicates that the manually parked sprinkler is stored in the controller.

Press  to confirm which will bring you back to the Sector Scout menu.

Calibrate all stations

This function will automatically calibrate all Sector Scout stations in ascending order, as described in “Auto Calibrate”.

Please follow the below menu instructions to optimize VP3 Sector Scout-based scheduling.

Sensor afterrun time

The integrated valve has a closing time of about 5-8 seconds, so the sensor will send a signal to the controller about 15 seconds before the sprinkler has reached the sector stop.
 The sensor afterrun time can also be used to make sure that the VP3 pops down when it reaches the sector stop. It can furthermore individually be adjusted for the left and right arc setting.
 Please note that the times specified are subject to changing values like rotation speed and operating pressure at the sprinkler and may therefore vary.
 Below is a schematic view of Sector Scout-based scheduling:

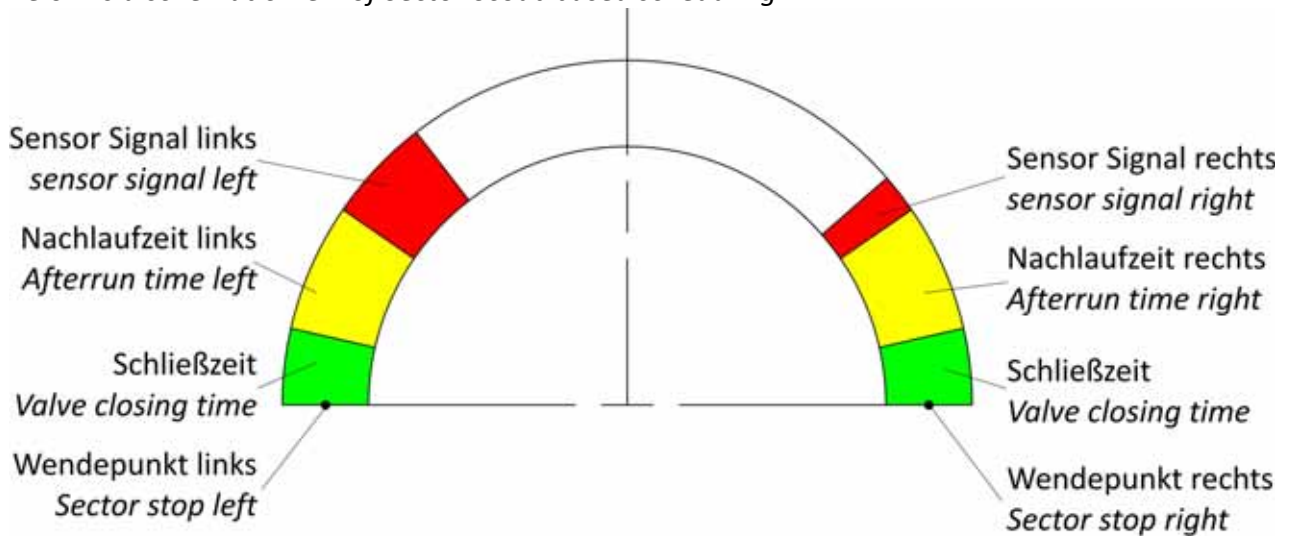

The following simplified version will appear on the display:



☆ Press  and  to select „Sensor setup“. Then press  to confirm.

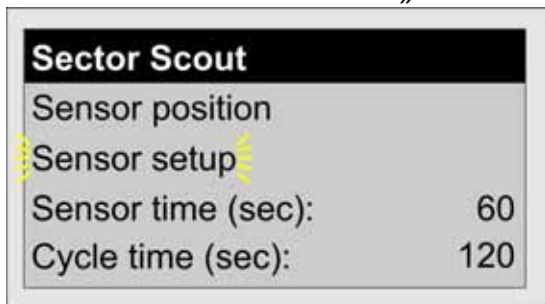

☆ Press and to select „Sensor afterrun times“



Press to confirm.

☆ To select a station, press and , then choose right or left side.

☆ Use or to set sensor afterrun time.

☆ Sensor afterrun time may be adjusted from 0-15 seconds. Factory setting: 5 seconds.

☆ Press to save changes and return to previous menu.

☆ Adjustment range: 0-15 sec.

☆ Factory setting: 5 sec.



Sensor time

The sensor time is used for monitoring. If the controller does not receive any signal from an active SC-station during the time set, it will stop this station and continue with the next station.

☆ Use and to select „Sensor time“

☆ Use or to increase/decrease the selected digit and press to save changes

Adjustment range: 60 – 150 seconds

Factory setting: 90 seconds

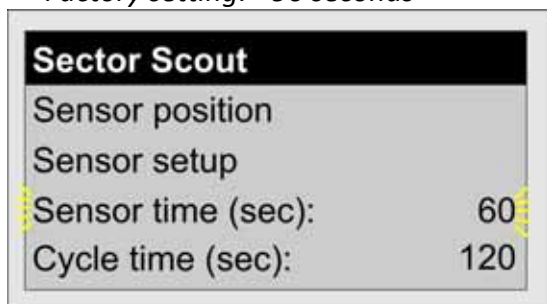



Note: If the designated time of a station is exceeded, the failure will be logged in the „sensor position“ menu (see next figure).

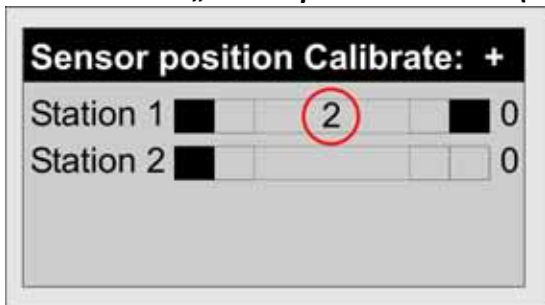

The number shown in the center of the sensor position bar equals the number of failures of the individual station. To delete the failure log, please calibrate this station.

Cycle time

The time entered in this menu is only used to calculate the runtime of an irrigation program. Due to the fact that the number of sector runs is entered in the controller instead of a certain time, the controller will calculate the runtime as follows:

Runtime = number of sector runs x cycle time

☆ Please set cycle time as follows:

☆ Use  and  to select „cycle time“

☆ Use  or  to increase/decrease the selected digit

Adjustment range: 60 – 180 seconds

Factory setting: 120 seconds

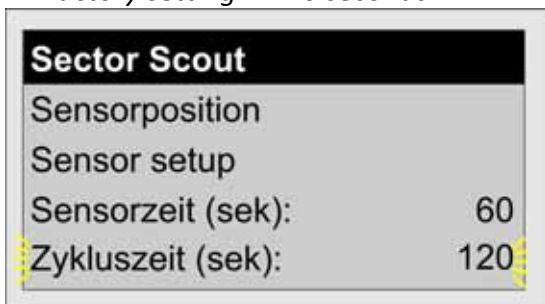

Note: At max. rotation speed the VP3 sprinkler needs about 70 seconds for a sector of 180°. The sector time should be at least 50 % longer so that the calculated runtime is definitely longer than the actual runtime in order to avoid overlapping start times.

Auto mode - Sector Scout sprinklers

Instead of a status bar, menus

- ☆ Auto
- ☆ Manual start program
- ☆ Manual start sprinkler

will display a sensor position bar for stations with Sector Scout sprinklers.
For detailed information please see next paragraph „sensor position bar“.

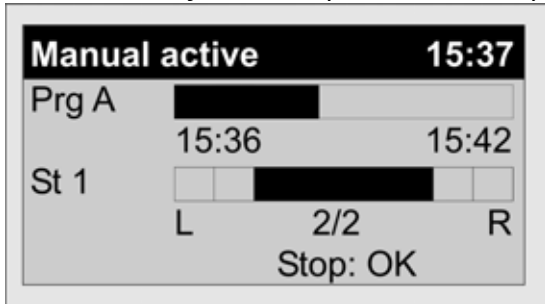

Sensor position bar

The sensor position bar will appear during calibration and operation (see previous paragraph) and displays the following states:

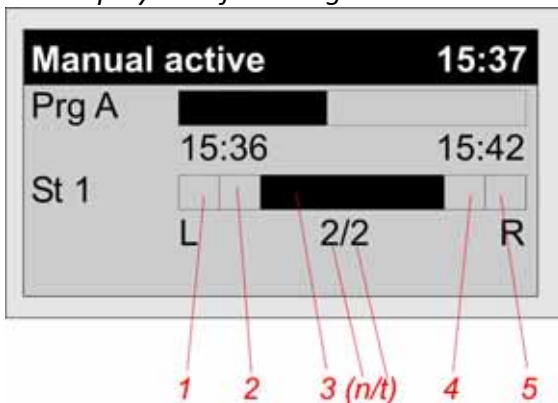

Field	Status	Meaning
1	on	Sprinkler in parking position on the left hand side
1	flashing	Sprinkler runs on the left hand side
2	on	Signal from sensor on the left hand side
3	flashing	Sprinkler runs in the center
3	n/t	n = number of sector runs finished t = total number of sector runs
4	on	Signal from sensor on the right hand side
5	on	Sprinkler in parking position on the right hand side
5	flashing	Sprinkler runs on the right hand side
1+5	flashing	Sprinkler is not calibrated
3	X	If this field shows only one digit it implies how many times the sensor time has been exceeded (see paragraph „sensor time“).

6. Maintenance

Protection

The controller is protected by a sensitive

T 0,2 AH 250 V

fuse.

The most common cause of a blown fuse is a short-circuited control cable of a valve. A short circuit is briefly indicated by a check on the screen.

Then the display switches off completely and all messages disappear.

Replace Fuse

8. Unplug the controller from the mains.
9. Remove the front cover by unscrewing its screws. The fuse is located on the right, above the terminals for the power supply cable (see chapter 5 –Controller)
10. Remove the faulty fuse from the holder.
11. Install a new fuse.
12. Replace the front cover.
13. Plug the power supply cable unit into the mains.
14. Check proper function of the controller.

WARNING



The controller is protected by a 0.2AH (slow) fuse.

Any attempt to bridge (bypass) the fuse or to replace it with a different type may result in serious injuries and/or damage to the unit.

Increase Number of Stations to be Controlled by the Controller

Factory setting of controller (SG49152) = 4 stations (equals 2 Sector Scout stations)

Should you need to increase the existing number of stations, you can do so in steps of 4 stations up to a maximum of 24 stations.

Order the required number of additional **output modules No. SB49112** from your local supplier. Each module comprises 4 stations.

Install Output Modules

1. *Unplug the controller from the mains.*
2. *Remove front cover.*
3. *Press the new output module upwards into the terminal board.
Replace the fixing screw and connect the coil cable.*
4. *Check proper function of the system.*
5. *Set station run time of the irrigation program for the new modules as described earlier.*

The controller software automatically detects the number of stations installed. This number cannot be exceeded during programming.

Replace Output Module

1. *Unplug the controller from the mains.*
2. *Remove front cover.*
3. *Disconnect the power supply cable from the damaged expansion module.*
4. *Unscrew the module fixing screw.*
5. *Pull the output module downwards from the terminal board.*
6. *Press the new output module upwards into the terminal board.
Replace fixing screw and connect the coil cable.*
7. *Check proper function of the system.*



Note

The output module (see chapter 5 – The Controller) is replaceable. It has been designed to burn in case of an over-voltage on the field side to protect the controller motherboard from damage. Chapter 7 – Troubleshooting provides guidance for analysing various faults of output modules.

7. Troubleshooting

Problem	Cause	Remedy
The display shows irrigation in progress, but the valve does not open.	1. No voltage on the valve coil.	- Check cabling. - Measure coil voltage.
	2. Faulty valve coil.	Replace coil.
	3. No water pressure.	Check pump and pump relay.
	4. No voltage at the valve output.	Replace output module.
Irrigation is switched off, but the valve is open. The LED of the active station is off.	1. Voltage on the coil. Faulty expansion module.	Replace output module.
	2. No voltage on the coil. Valve mechanically damaged.	Check valve.
Displayed time and day is not correct.	Long-term power outage.	Set time and day.
Screen displays (check) ✓	Short-circuited or overloaded output.	Remove the short circuit. Unplug controller from the mains to reset it.
Automatic irrigation does not start.	1. Controller is not set to AUTO mode	Turn dial to AUTO
	2. Incorrect start time.	Set a correct start time.
	3. No particular day has been set in this program.	Set watering days.
The display is blank.	1. Unit is disconnected from the mains, power cut.	Check the mains parameters: 230V/50Hz.
	2. Fuse blown.	Replace fuse. For the type see the printed circuit board (T200mA 250V).
	3. Defective motherboard.	Replace the controller.
No signal is detected from the sensor	Sensor not connected correctly	Check wiring (see wiring scheme page 7)
	Station or sensor not activated	Activate station
	Distance between sensor and switching cam is too big	Check distance. Try holding a metal piece in front of the sensor to check if signal is detected The yellow LED at the sensor also shows this signal
VP3 SC sprinkler does not go into parking position	Station not calibrated	Calibrate station once again
	Station setting has been changed manually	Calibrate station once again
VP3 SC does not pop down at sector stop	Afterrun time not well adjusted	Optimize afterrun time

Example for Irrigation Schedule

Station	run time Program A	run time Program B	run time Program C
1	40'		
2	40'		
3	30'		
4	30'		
5	30'		
6	30'		
7	30'		
8	-		
9	-		
10	-		
11	-		
12	-		

Start time	Program A							Program B							Program C							
1	Time	18:00							--:--							--:--						
	Watering days	Mo	Tu	We	Th	Fr	Sa	Su	Mo	Tu	We	Th	Fr	Sa	Su	Mo	Tu	We	Th	Fr	Sa	Su
2	Time	23:30							--:--							--:--						
	Watering days	Mo	Tu	We	Th	Fr	Sa	Su	Mo	Tu	We	Th	Fr	Sa	Su	Mo	Tu	We	Th	Fr	Sa	Su
3	Time	--:--							--:--							--:--						
	Watering days	Mo	Tu	We	Th	Fr	Sa	Su	Mo	Tu	We	Th	Fr	Sa	Su	Mo	Tu	We	Th	Fr	Sa	Su
4	Time	--:--							--:--							--:--						
	Watering days	Mo	Tu	We	Th	Fr	Sa	Su	Mo	Tu	We	Th	Fr	Sa	Su	Mo	Tu	We	Th	Fr	Sa	Su

Layout for Irrigation Schedule

Station	run time Program A	run time Program B	run time Program C
1			
2			
3			
4			
5			
6			
7			
8			
9			
10			
11			
12			

Start time	Program A	Program B	Program C
1	Time		
	Watering days	Mo Tu We Th Fr Sa Su	Mo Tu We Th Fr Sa Su
2	Time		
	Watering days	Mo Tu We Th Fr Sa Su	Mo Tu We Th Fr Sa Su
3	Time		
	Watering days	Mo Tu We Th Fr Sa Su	Mo Tu We Th Fr Sa Su
4	Time		
	Watering days	Mo Tu We Th Fr Sa Su	Mo Tu We Th Fr Sa Su

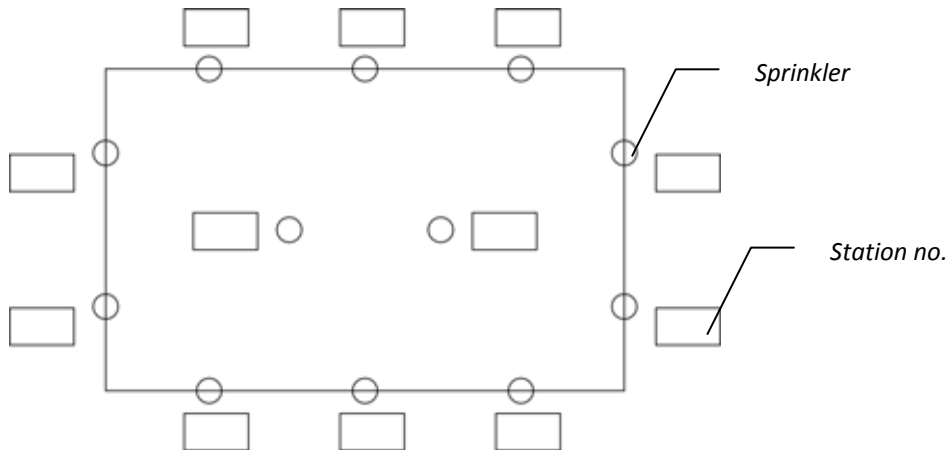



Declaration of Compliance

The PERROT controller, type:

Water Control + SC

complies with the following standards:

DS/EN 50081-1: 1992, part 1

DS/EN 50081-1: 1997, part 1

The undersigned hereby declares that the controller (Water Control + SC) complies with the above mentioned standards.

*Günther Flik
Manager Product Support
Regnerbau Calw GmbH
Industriestrasse 19-29
75382 Althengstett
Germany*

Issued on March 17, 2015

We reserve the right to make modifications according to current technological developments, without prior notice.



Notizen / Notes



Notizen / Notes



**Für weitere Informationen stehen wir Ihnen gerne zur Verfügung.
*We remain at your full disposal for any further information you may require!***

REGNERBAU CALW GmbH
Industriestrasse 19-29
75382 Althengstett / Germany
Tel. +49 / 7051 / 162-0
Fax. +49 / 7051 / 162-133
<http://www.perrot.de>



ZW99513